

V5 Set Up Instructions

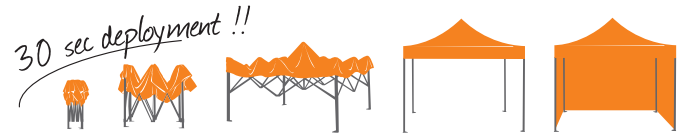

For more information on set up instructions, please call your distributor.

Table of Contents

Tent Components & Warnings	Page 3
A. How To Set Up Your Tent	Page 4 - 5
B. How To Set Up Walls	Page 6
C. How To Set Up Rail Skirts	Page 7
D. How To Take Down Your Tent	Page 8

Cleaning & Care

Warning: Do NOT use bleach or harsh detergents to clean your canopy top, walls or rail skirts.

If you need to clean your top, walls or rail skirts, we recommend that you dry clean them longer color vibrancy. You can also use a pressure washer on very low using only mild soap or Simple Green® and water.



1. To clean with a pressure washer, leave the top and the walls on the frame.
2. Then, gently moisten your top and walls with water and use a mild soap or Simple Green® and a soft brush to clean them.
3. Rinse out the soap and let them air dry.

Note: Never put your top or walls and rail skirts away if they are damp or wet. Doing so will damage the material.

Set Up Instructions

Congratulations on the purchase of your tent. Please read the instructions before setting up your tent. Failure to do so may void warranty. It is the user's responsibility to take special precautions before setting up your tent.

Tent Components

Note: Before you begin, please make sure you go over your tent's components. Failure to do so may result in damaging your tent.

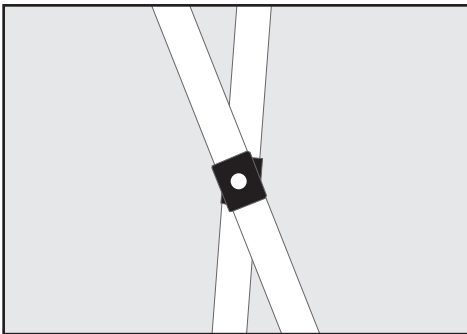

Truss Bars

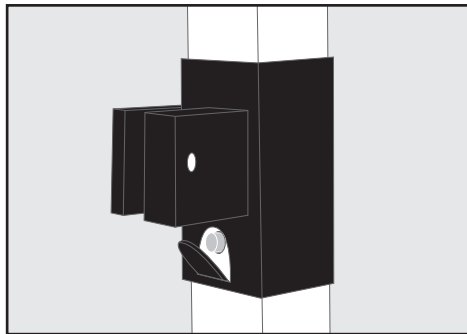

Frame Push Button

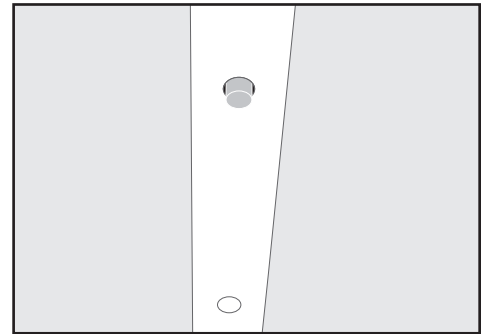

Leg Push Button

WARNINGS

Important: Read this information before proceeding. Non-compliance with these warning instructions will void your warranty. It is the user's responsibility to take the following precautions at all times.

- Always stake or weigh down your tent.
- Do not use, set up or leave your tent in any potentially harsh weather conditions: strong winds, rain, hail, sleet, snow, drizzle, or lightning.
- Ins'tent tents are designed as temporary shelter only.
- Be cautious while handling. Avoid pinching hands or fingers as frame opens or closes.
- Do not leave your tent unattended.
- Keep all flame and heat sources away from fabric top and walls.
- Do not allow water of any kind to accumulate on the tent.
- Make sure your tent is completely dry before storing.
- Keep your tent off of steep slopes and inclines.
- Do not use strong detergents to clean your canopy. Only mild detergent with warm water.
- Never wash the tent top and walls in a washing machine.
- For further instructions on how to clean your tent, please see **page 2**.
- Do not ship your tent with the top on the frame. Doing so could cause tears in the fabric.

A. How To Set Up Your Tent

Important: Your top, walls, and rail skirts will be shipped separately from your tent hardware.

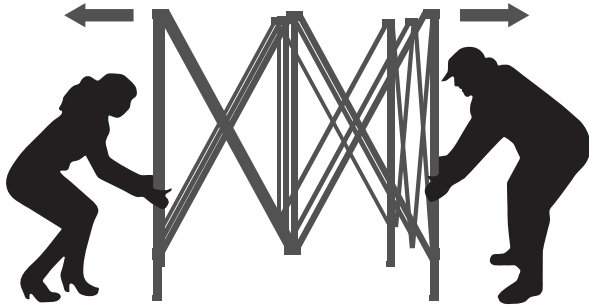

1. Place your folded tent frame on its feet in the center of your setup space. With a partner, grab legs on opposite sides, extend and move backwards, while partially spreading the frame out.



2. Then, get a friend to help you put the top on. Take your new top by the corners and throw the top over the partially expanded frame. Line up all four corners of the top with the corners of the frame.

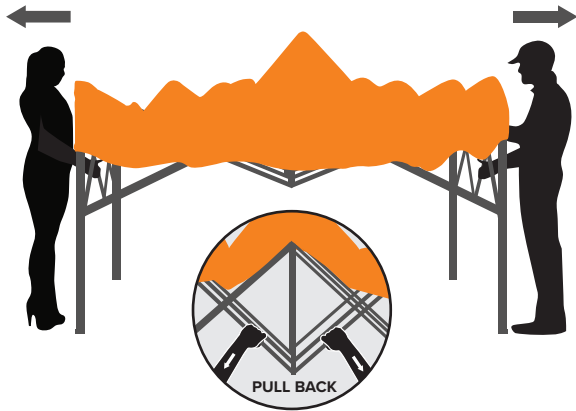

3. Expand the frame further by grabbing the bottom truss bars and by pulling back until the frame is almost fully extended.

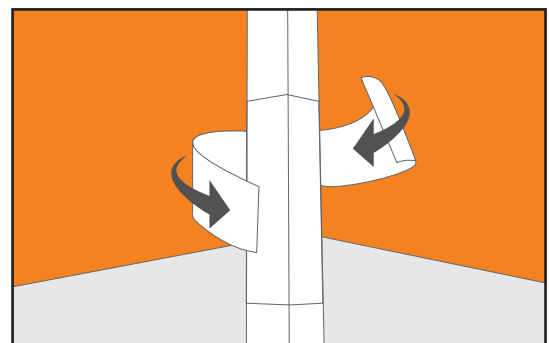

4. Then, attach the canopy top to the corners by wrapping the 2" hook and loop fastener straps around each corner.

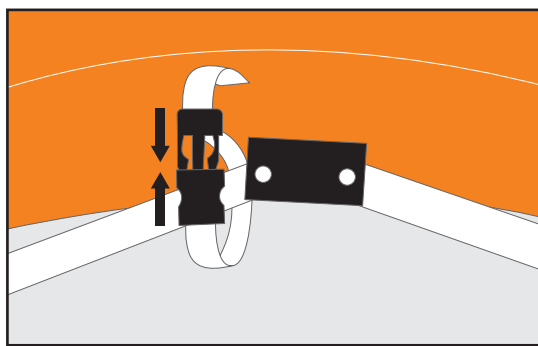

5. Once the top is securely placed on the truss bars, secure the valance strap to the top junction pieces of the frame.



6. Extend the frame as far as it can go by taking the truss bars and pushing the bottom outward like you did earlier.

A. How To Set Up Your Tent *Continued*

Note: You do not have to remove your top after each event. If it is wet, make sure that it is fully dry before putting it away.

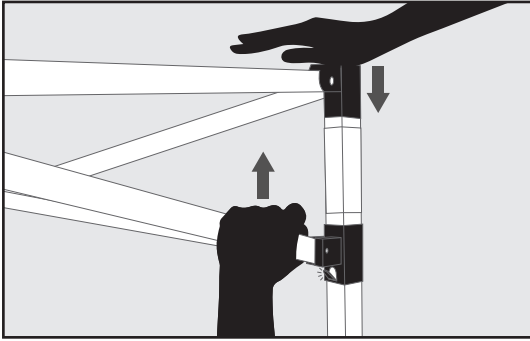

7. Lock the frame in place by putting your hand on the top of the corner cap and pushing the leg slider up until you hear the push button click into place. Repeat this for all four corners.

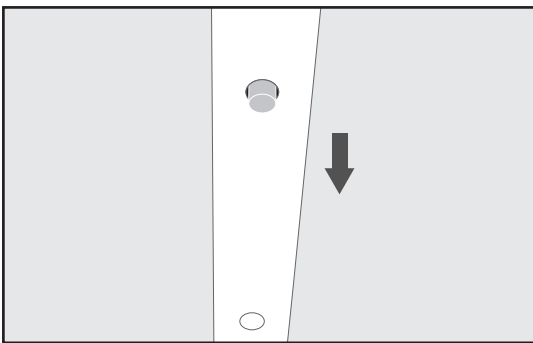

9. Adjust the legs to the desired height by pressing the push button and sliding the legs out to the desired level. Do this on the other side of the tent.



8. With a friend, lift two of the legs and slide out the bottom portion of the leg until it locks in place.



10. Repeat this step on the other side of the tent.



You're all set. Enjoy!

B. How To Set Up Walls

Important: Your top, walls, and rail skirts will be shipped separately from your tent hardware.

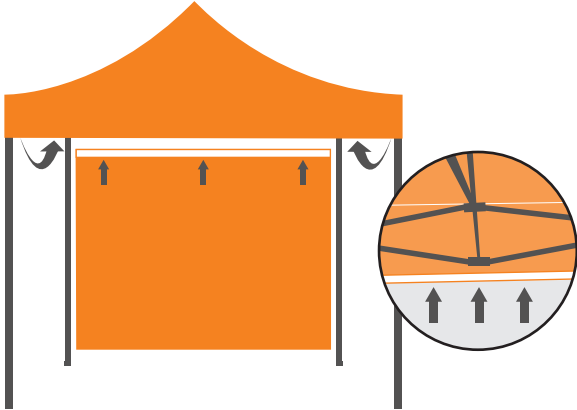

1. Locate the hook and loop fasteners on your tent's top and on the inside of your wall.

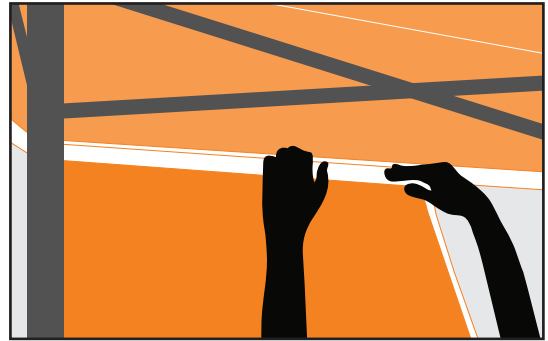

2. Next, attach your wall's hook & loop fasteners to the hook and loop fasteners on your tent's top.

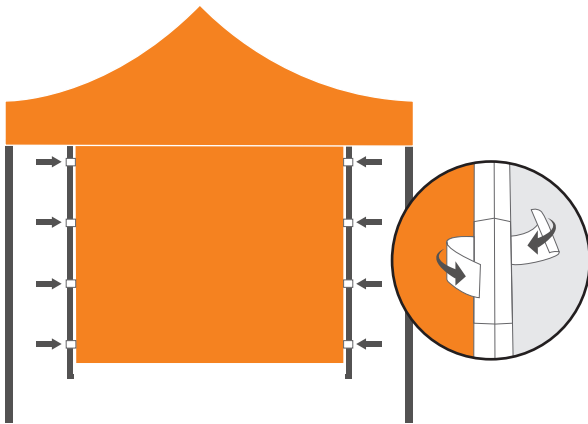

3. Lastly, your polyester side walls should come with 4 hook and loop fasteners on the each side. Attach these onto the legs of the tent.

C. How To Set Up Rail Skirts

Important: Your top, walls, and rail skirts will be shipped separately from your tent hardware.

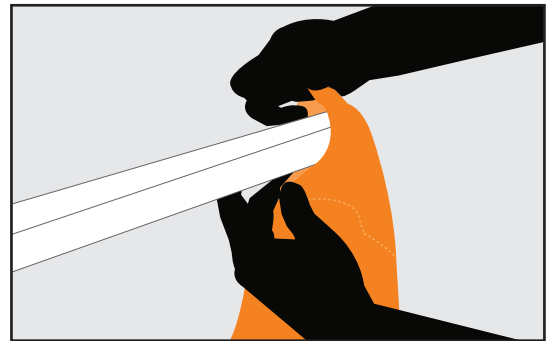
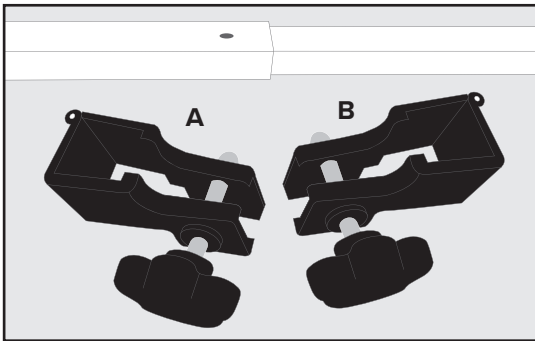

1. Locate your rail skirts poles and clamps. You should have a right clamp and a left clamp.

2. Begin by extending the pole until it locks. Then with a partner, insert the pole through the sleeve of the rails skirt and make sure the pole ends are visible. Have your partner hold the pole while you prepare the clamps.

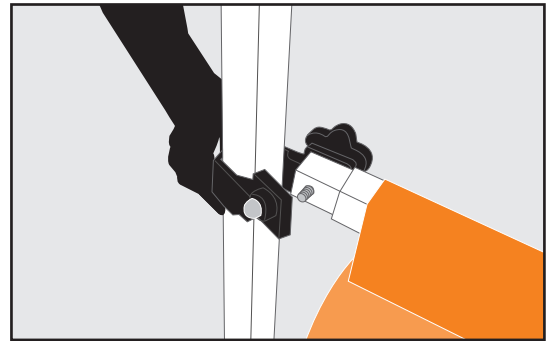
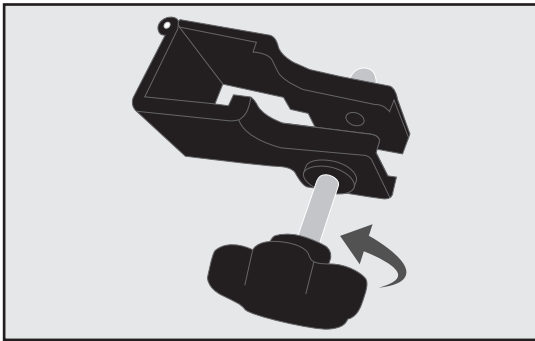

3. Once you have located the rail skirt clamps. Unscrew the knobs by turning them counter clockwise.

4. Open the clamp and wrap it around to the top portion of the leg right above where the inferior leg meets the superior leg. Then, insert the pole through the opening of the clamp and screw the knob on tightly. The knob should be facing outward.

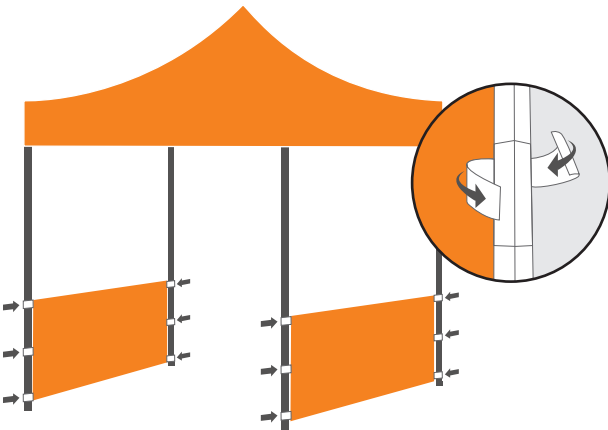

5. Wrap the 3 rail skirts hook & loop fasteners around the tent legs.

D. How To Take Down Your Tent

Note: You do not have to remove your top after each event. If it is wet, make sure that it is fully dry before putting it away.

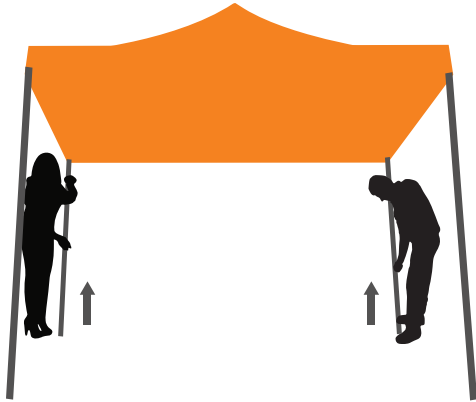

1. With a friend take two of the legs, lift them up and push the thumb-lock to release the legs and allow them to slide down. Then, repeat this on the other side.

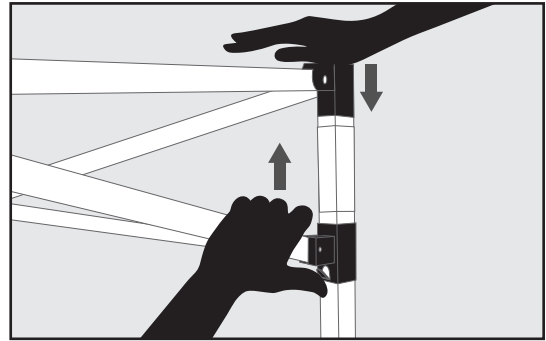

2. Put one hand on the corner cap. With the other hand, push up slightly on the truss bar to release the pressure on the corner button. Then press the thumb-lock to allow it to slide down. Repeat this on all four corners.

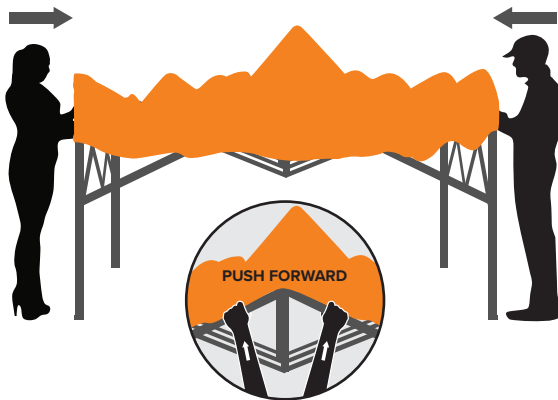

3. Grab the top truss bars and push forward until the legs slide close enough for you to reach them and the tent is closed.



4. Store your tent in one of our professional roller-bags or heavy-duty transport cases to be on your way and ready for your next event.